



## 特点

- 国际标准封装，芯片与底板电气绝缘耐压 3000V
- 全压接式结构，优良的温度特性和功率循环能力
- 350A以下模块皆为强迫风冷，400A以上模块，风冷，水冷选用

## 典型应用

- 直流电源，各种稳压电源
- 工业加热控制
- 电机软起动，整流电源
- 变频器，充电机，电池充放电

IT(AV)	800A
VDRM/VRRM	600-2400V
ITSM	20 KA
I <sup>2</sup> <sub>t</sub>	2600 10 <sup>3</sup> a <sup>2</sup> s

符号	参数	测试条件	结温 T <sub>J</sub> (°C)	参数值			单位
				最小	典型	最大	
I <sub>F(AV)</sub>	正向平均电流	180° 正弦半波, 50HZ 单面散热, T <sub>C</sub> =100°C	150		800	850	A
I <sub>F(RMS)</sub>	方均根电流		150			1256	A
V <sub>RRM</sub>	反向重复峰值电压	V <sub>RRM</sub> tp=10ms V <sub>RSM</sub> =V <sub>RRM</sub> +200V	150		1600		V
I <sub>RRM</sub>	反向重复峰值电流	V <sub>RM</sub> =V <sub>RRM</sub>	150			20	mA
I <sub>FSM</sub>	正向不重复浪涌电流	10ms底宽, 正弦半波 V <sub>R</sub> =0.6V <sub>RRM</sub>	150			20.0	KA
I <sup>2</sup> <sub>t</sub>	浪涌电流平方时间积					2600	A <sup>2</sup> S*10 <sup>3</sup>
V <sub>FO</sub>	门槛电压		150			0.75	V
r <sub>F</sub>	斜率电阻					0.32	mΩ
V <sub>FM</sub>	正向峰值电压	I <sub>FM</sub> =1800A	25			1.40	V
R <sub>th(j-c)</sub>	热阻抗(结至壳)	180° 正弦波, 单面散热				0.054	°C/W
R <sub>th(c-h)</sub>	热阻抗(壳至散)	180° 正弦波, 单面散热				0.024	°C/W
V <sub>iso</sub>	绝缘电压	50Hz,R.M.S,t=1min,I <sub>iso</sub> :1mA(max)			3000		V
F <sub>M</sub>	安装扭矩(M5)				3		N-m
	安装扭矩(M6)				4		N-m
T <sub>stq</sub>	储存温度			-40		125	°C
W <sub>t</sub>	质量						g
Outline	外形	180 X 78mm					

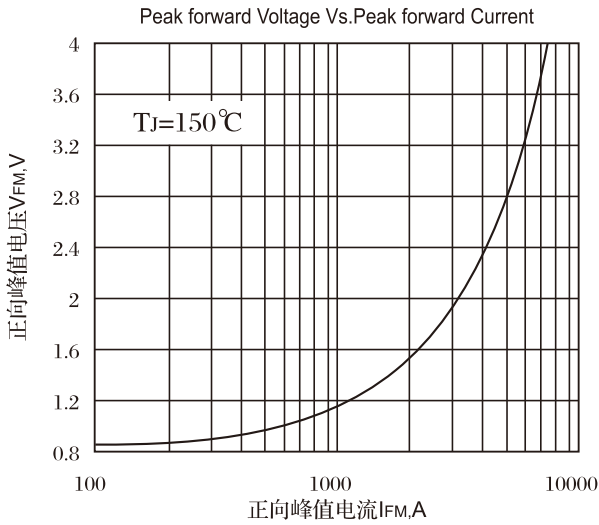

Fig.1 正向伏安特性曲线

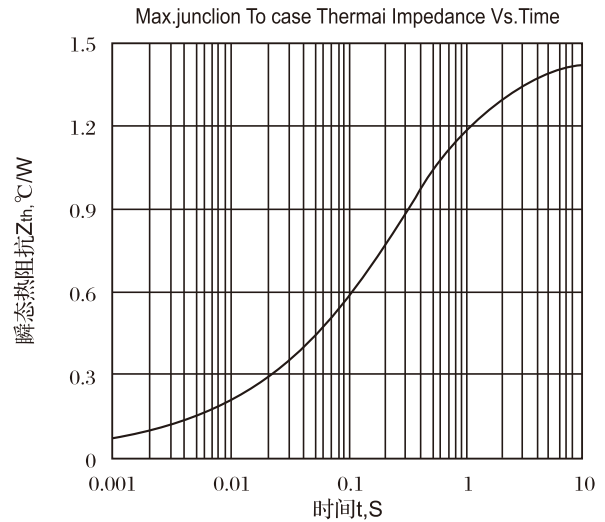

Fig.2 瞬态热阻抗曲线

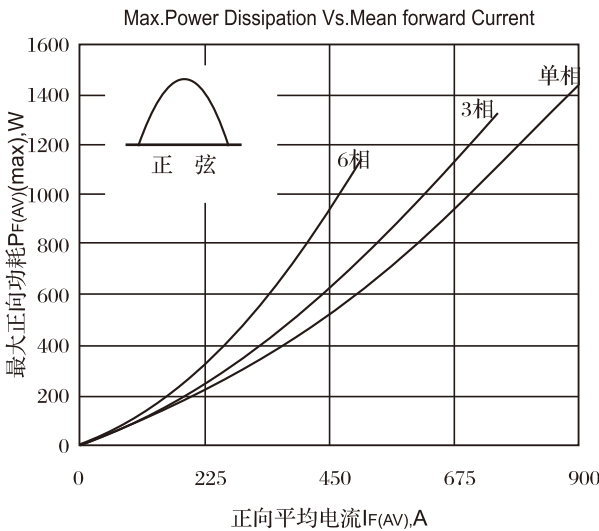

Fig.3 最大正向功耗与平均电流关系曲线

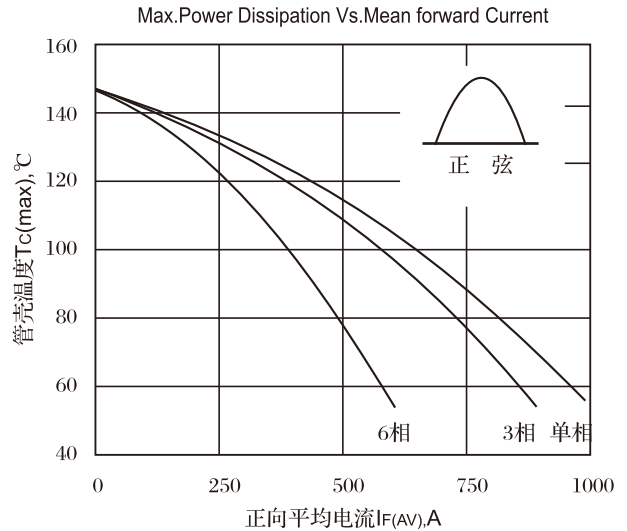

Fig.4 管壳温度与正向平均电流关系曲线

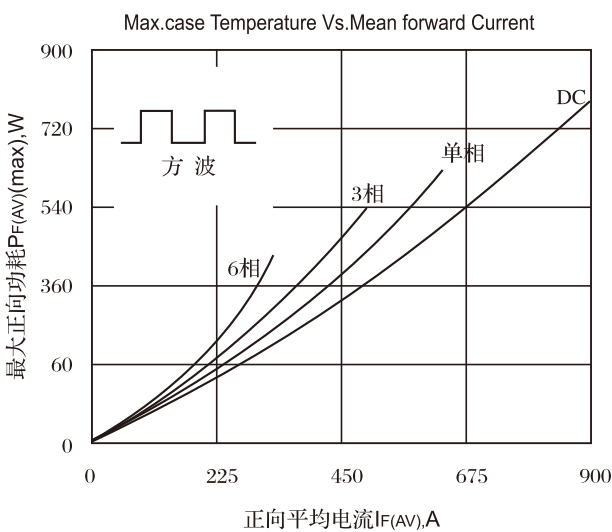

Fig.5 最大正向功耗与平均电流关系曲线

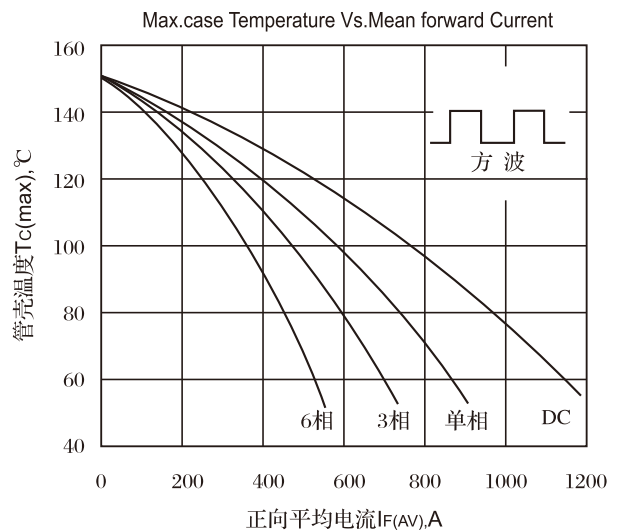

Fig.6 管壳温度与正向平均电流关系曲线

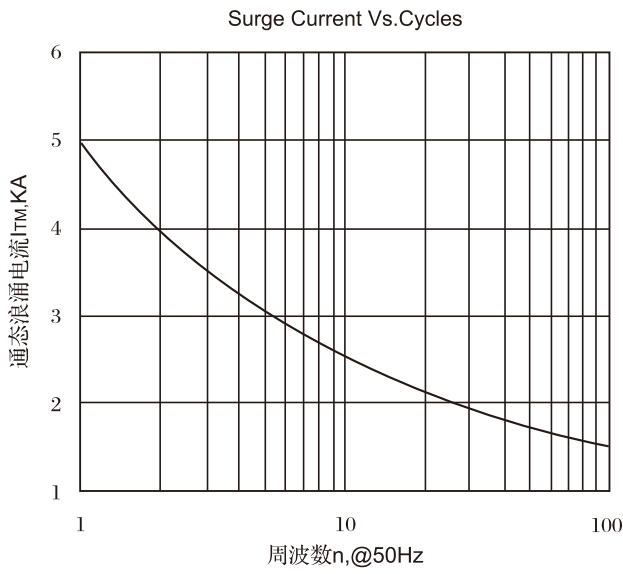

Fig.7 通态浪涌电流与周波数的关系曲线

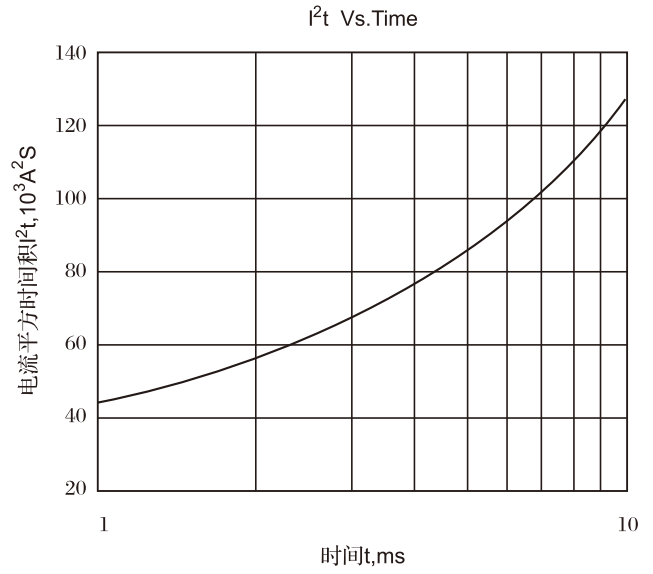
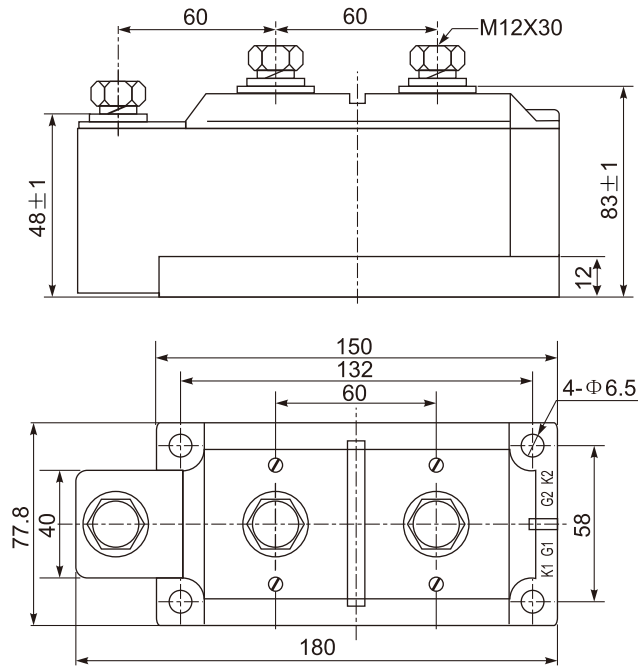

Fig.8 I<sup>2</sup>t 特性曲线

外形图:



线路图:

MD

